









Industrial Batteries – Network Power
Sonnenschein Solar
Safe storage capacity for renewable energy.

Specifications

The compact alternative for smaller solar applications.

Sonnenschein Solar batteries are specially designed for small to medium performance requirements in leisure and consumer applications. The advantages of the maintenance free VRLA - batteries are enhanced by the worldwide high reputation and technical image of the dryfit technology. Typical applications are weekend and holiday houses without mains supply, street solar stations, information signs, parking meters, wireless emergency phone boxes and also other safety equipment power supplies.

	
Valve regulated	Grid plate
	
Nominal capacity 6.6-230 Ah	Block battery
	
800 cycles acc. to IEC 896-2	Maintenance-free
	
Proof against deep discharge acc. to DIN 43 539 T5	Recyclable



Technical characteristics and data

Type	Part number	Nominal voltage	Nominal capacity	Discharge current	Length (l) max. mm	Width (b/w) max. mm	Height up to top of cover (h1) max. mm	Height incl. connectors (h2) max. mm	Weight approx. kg	Terminal	Terminal position
		V	C ₁₀₀ 1.8 V/C Ah	I ₁₀₀ A							
S12/6.6 S	NGSO1206D6HS0SA	12	6.6	0.066	151.7	65.5	94.5	98.4	2.6	S-4.8	3
S12/17 G5	NGSO120017HS0BA	12	17.0	0.170	181.0	76.0	-	167.0	6.1	G-M5	1
S12/27 G5	NGSO120027HS0BA	12	27.0	0.270	167.0	176.0	-	126.0	9.7	G-M5	1
S12/32 G6	NGSO120032HS0BA	12	32.0	0.320	197.0	132.0	160.0	184.0	11.2	G-M6	2
S12/41 A	NGSO120041HS0CA	12	41.0	0.410	210.0	175.0	-	175.0	14.8	A-Terminal	1
S12/60 A	NGSO120060HS0CA	12	60.0	0.600	261.0	136.0	208.0	230.0	19.0	A-Terminal	1
S12/85 A	NGSO120085HS0CA	12	85.0	0.850	353.0	175.0	-	190.0	26.8	A-Terminal	1
S12/90 A	NGSO120090HS0CA	12	90.0	0.900	330.0	171.0	213.0	236.0	30.0	A-Terminal	2
S12/130 A	NGSO120130HS0CA	12	130.0	1.300	286.0	269.0	208.0	230.0	39.5	A-Terminal	4
S12/230 A	NGSO120230HS0CA	12	230.0	2.300	518.0	274.0	216.0	238.0	67.0	A-Terminal	3

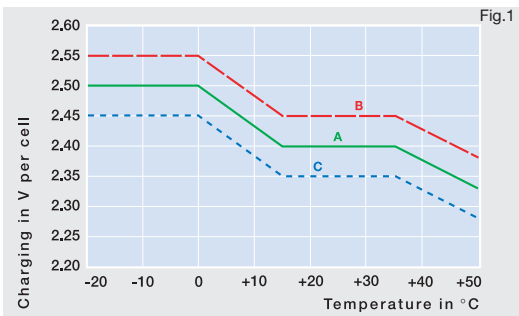

Charge mode (to Fig.1):

- 1.) with switch regulator (two-step controller)
 - charge on curve **B** (max.charge voltage) for max.2 hrs/day
 - then switch over to continuous charge - curve **C**
- 2.) Standard charge (without switching) - curve **A**
- 3.) Boost charge (Equalizing charge with external generator)
 - charge on curve **B** for max. 5 hrs/month, then switch over to curve **C**

Type	Capacities C ₁ – C ₁₀₀ (20°C)				
	C ₁ 1.70 V/C	C ₅ 1.70 V/C	C ₁₀ 1.70 V/C	C ₂₀ 1.75 V/C	C ₁₀₀ 1.80 V/C
S12/6.6 S	2.9	4.6	5.1	5.7	6.6
S12/17 G5	9.3	12.6	14.3	15.0	17.0
S12/27 G5	15.0	22.1	23.5	24.0	27.0
S12/32 G6	16.9	24.4	27.0	28.0	32.0
S12/41 A	21.0	30.6	34.0	38.0	41.0
S12/60 A	30.0	42.5	47.5	50.0	60.0
S12/85 A	55.0	68.5	74.0	76.0	85.0
S12/90 A	50.5	72.0	78.0	84.0	90.0
S12/130 A	66.0	93.5	104.5	110.0	130.0
S12/230 A	120.0	170.0	190.0	200.0	230.0

Drawings with terminal position, terminal and torque

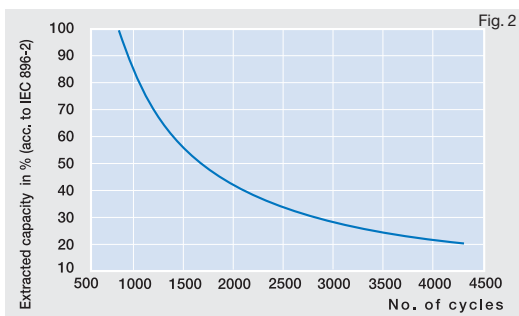
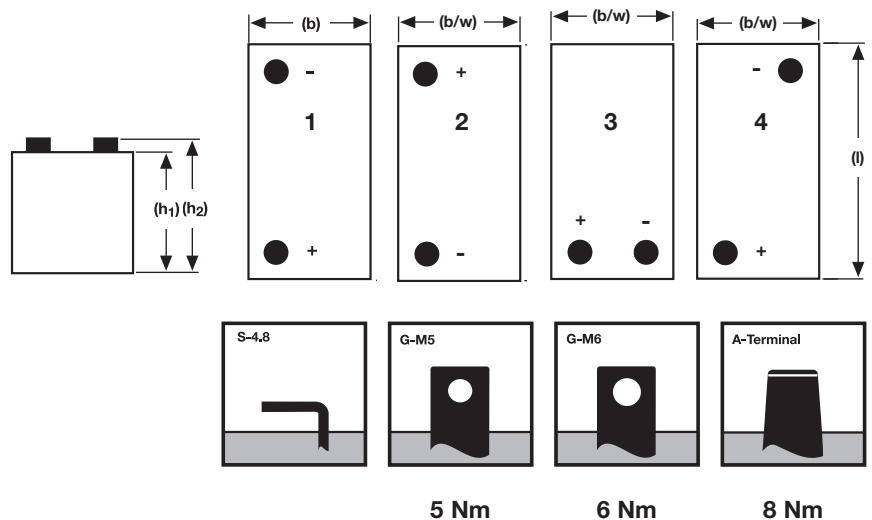









(to Fig. 2)

Endurance in cycles according to IEC 896-2

Not to scale!

Safe power supply for medium performance.

The Sonnenschein Solar Block battery range is very powerful and reliable in rough application conditions. As well as for use in private areas like holiday and weekend houses with more consumer terminals, this range is the ideal energy source for medium industrial solar systems, small solar and wind powerstations, offshore buoys, yachts and measuring stations as well as for other safety equipment power supplies.

	
Valve regulated	Grid plate
	
Nominal capacity 60-330 Ah	Block battery
	
1200 cycles acc. to IEC 896-2	Maintenance-free (no topping up)
	
Proof against deep discharge acc. to	Recyclable



Technical characteristics and data

Type	Part number	Nominal voltage	Nominal capacity	Discharge current	Length (l)	Width (b/w)	Height up to top of cover	Height incl. connectors	Weight approx. kg	Terminal	Terminal position
		V	C ₁₀₀ 1.8 V/C Ah	I ₁₀₀ A	max. mm	max. mm	of cover (h1) max. mm	incl. connectors (h2) max. mm			
SB12/60 A	NGSB120060HS0CA	12	60	0.60	278	175	–	190	19.0	A-Terminal	1
SB12/75 A	NGSB120075HS0CA	12	75	0.75	330	171	214	236	26.5	A-Terminal	2
SB12/100 A	NGSB120100HS0CA	12	100	1.00	513	189	195	223	36.5	A-Terminal	3
SB12/130 A	NGSB120130HS0CA	12	130	1.30	513	223	195	223	45.5	A-Terminal	3
SB12/185 A	NGSB120185HS0CA	12	185	1.85	518	274	216	238	62.5	A-Terminal	3
SB6/200 A	NGSB060200HS0CA	6	200	2.00	190	244	254	275	29.5	A-Terminal	4
SB6/330 A	NGSB060330HS0CA	6	330	3.30	312	182	337	359	47.0	A-Terminal	4

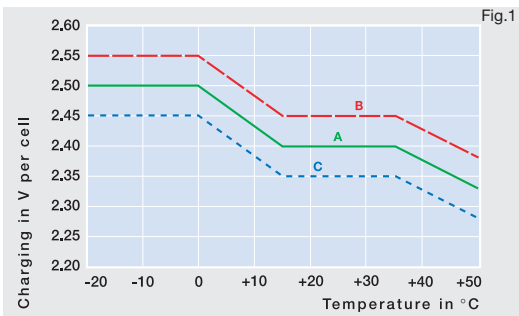

Type	Capacities C ₁ – C ₁₀₀ (20°C)				
	C ₁ 1.70 V/C	C ₅ 1.70 V/C	C ₁₀ 1.70 V/C	C ₂₀ 1.75 V/C	C ₁₀₀ 1.80 V/C
SB12/60 A	34	45	52	56	60
SB12/75 A	48	60	66	70	75
SB12/100 A	57	84	89	90	100
SB12/130 A	78	101	105	116	130
SB12/185 A	103	150	155	165	185
SB6/200 A	104	153	162	180	200
SB6/330 A	150	235	260	280	330

Charge mode (to Fig.1):

- with switch regulator (two-step controller)
 - charge on curve **B** (max.charge voltage) for max.2 hrs/day
 - then switch over to continous charge - curve **C**
- Standard charge (without switching) - curve **A**
- Boost charge (Equalizing charge with external generator)
 - charge on curve **B** for max. 5 hrs/month, then switch over to curve **C**

Drawings with terminal position, terminal and torque

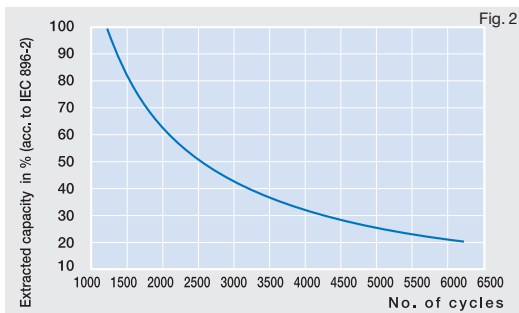
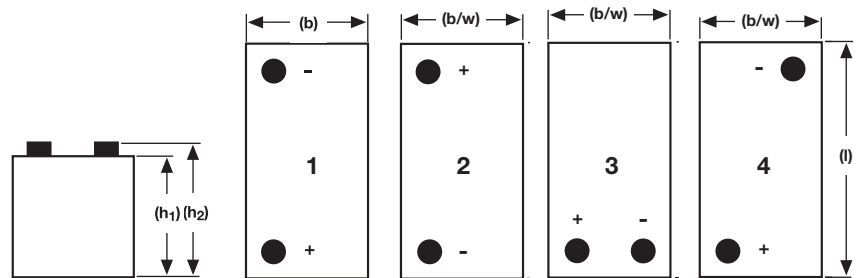

(to Fig. 2)

Endurance in cycles according to IEC 896-2

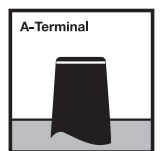









8 Nm

Not to scale!

Sonnenschein A600 Solar batteries are developed for medium to large solar powered applications. The recyclability and long storage life without recharge makes this environmentally friendly solar battery system absolutely recommendable for various requirement profiles. Typical applications for these maintenance free VRLA-batteries with successful dryfit technology, are solar and wind power stations, power distribution companies, telecommunications, railways and many other safety equipment power supplies.



			
Valve regulated	Tubular plate	Nominal capacity 240 – 3500 Ah	Single cell
			
1600 cycles acc. to IEC 896-2	Maintenance-free (no topping up)	Proof against deep discharge acc. to DIN 43 539 T5	Recyclebar



Technical characteristics and data

Type	Part number	Nominal voltage V	Nominal capacity C ₁₀₀ 1.85 V/C Ah	Dis-charge current I ₁₀₀ A	Length (l)	Width (b/w)	Height up to top of cover (h1)	Height incl. con- nectors (h2)	Installed length (B/L) mm	Weight approx. kg	Terminal	Pole pairs
					max. mm	max. mm	max. mm	max. mm				
4 OPzV 240	NGS6020240HS0FA	2	240	2.4	105	208	360	398	113	19.5	F-M8	1
5 OPzV 300	NGS6020300HS0FA	2	300	3.0	126	208	360	398	134	23.5	F-M8	1
6 OPzV 360	NGS6020360HS0FA	2	360	3.6	147	208	360	398	155	28.0	F-M8	1
5 OPzV 400	NGS6020400HS0FA	2	400	4.0	126	208	475	513	134	31.0	F-M8	1
6 OPzV 500	NGS6020500HS0FA	2	500	5.0	147	208	475	513	155	36.5	F-M8	1
7 OPzV 600	NGS6020600HS0FA	2	600	6.0	168	208	475	513	176	42.0	F-M8	1
6 OPzV 720	NGS6020720HS0FA	2	720	7.2	147	208	650	688	155	50.0	F-M8	1
8 OPzV 960	NGS6020960HS0FA	2	960	9.6	215	193	650	688	220	68.0	F-M8	2
10 OPzV 1200	NGS6021200HS0FA	2	1200	12.0	215	235	650	688	220	82.0	F-M8	2
12 OPzV 1400	NGS6021400HS0FA	2	1400	14.0	215	277	650	688	220	97.0	F-M8	2
12 OPzV 1700	NGS6021700HS0FA	2	1700	17.0	215	277	800	838	220	120.0	F-M8	2
16 OPzV 2300	NGS6022300HS0FA	2	2300	23.0	215	400	775	815	223	160.0	F-M8	3
20 OPzV 2900	NGS6022900HS0FA	2	2900	29.0	215	490	775	815	223	200.0	F-M8	4
24 OPzV 3500	NGS6023500HS0FA	2	3500	35.0	215	580	775	815	223	240.0	F-M8	4

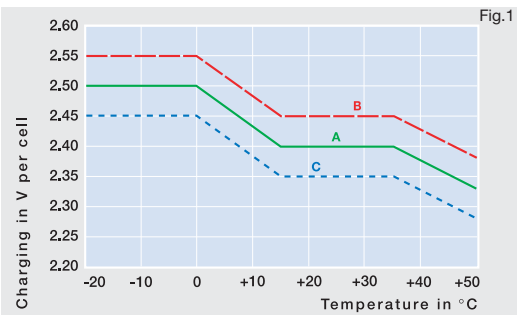

Charge mode (to Fig.1):

- with switch regulator (two-step controller)
 - charge on curve **B** (max.charge voltage) for max.2 hrs/day then switch over to continuous charge - curve **C**
- Standard charge (without switching) - curve **A**
- Boost charge (Equalizing charge with external generator)
 - charge on curve **B** for max. 5 hrs/month, then switch over to curve **C**

Type	Capacities C ₁ - C ₁₀₀ (20°C)				
	C ₁ 1.67 V/C	C ₃ 1.75 V/C	C ₅ 1.77 V/C	C ₁₀ 1.80 V/C	C ₁₀₀ 1.85 V/C
4 OPzV 240	108	151	175	200	240
5 OPzV 300	135	189	219	250	300
6 OPzV 360	162	227	263	300	360
5 OPzV 400	180	252	292	350	400
6 OPzV 500	225	315	365	420	500
7 OPzV 600	270	378	438	490	600
6 OPzV 720	324	454	526	600	720
8 OPzV 960	432	605	701	800	960
10 OPzV 1200	540	756	876	1000	1200
12 OPzV 1400	630	882	1022	1200	1400
12 OPzV 1700	765	1071	1241	1500	1700
16 OPzV 2300	1035	1449	1679	2000	2300
20 OPzV 2900	1305	1827	2117	2500	2900
24 OPzV 3500	1575	2205	2555	3000	3500

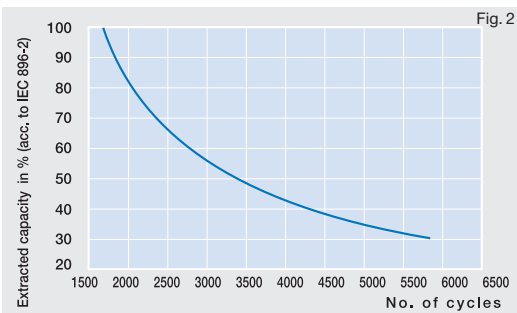

(to Fig. 2)

Endurance in cycles according to IEC 896-2

Drawings with terminal position, terminal and torque

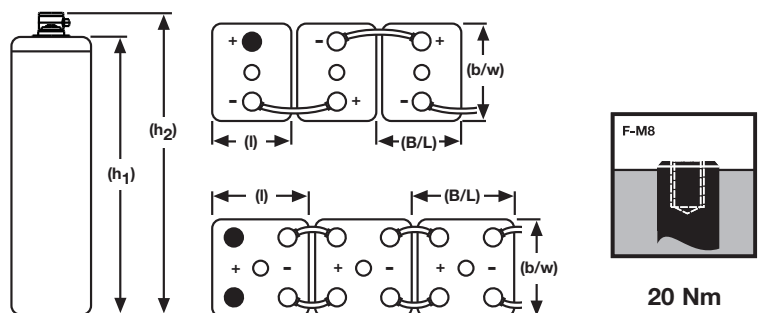

Not to scale!

Exide Technologies Industrial Energy – The Industry Leader.



Exide Technologies is the global leader in stored electrical energy solutions with subsidiaries in more than 80 countries. Based on over 100 years of experience in technological innovation, we are partners of OEM and serve the spare parts market for industrial and transportation applications.

Our Global Industrial Energy Business Unit offers an extensive range of storage products and services, including solutions for telecommunications

systems, railway applications, mining, photovoltaic (solar energy), uninterruptible power supply (UPS), electrical power generation and distribution, fork lifts and electric vehicles.

Exide Technologies takes pride in its commitment to a better environment. Its Total Battery Management programme, (an integrated approach to manufacturing, distributing and recycling of lead acid batteries), has been developed to ensure a safe and responsible life cycle for all of its products.

EXIDE TECHNOLOGIES
Industrial Energy

www.networkpower.exide.com

EXIDE
TECHNOLOGIES
INDUSTRIAL ENERGY