



# **HUB Communications Manager User's Manual**

## **About OutBack Power Systems**

OutBack Power Systems is a leader in advanced energy conversion technology. Our products include true sine wave inverter/chargers, maximum power point charge controllers, system communication components, as well as breaker panels, breakers, accessories, and assembled systems.

## **Notice of Copyright**

OutBack HUB Communications Manager User's Guide © 2008 All rights reserved.

## **Disclaimer**

UNLESS SPECIFICALLY AGREED TO IN WRITING, OUTBACK POWER SYSTEMS:

- (a) MAKES NO WARRANTY AS TO THE ACCURACY, SUFFICIENCY OR SUITABILITY OF ANY TECHNICAL OR OTHER INFORMATION PROVIDED IN ITS MANUALS OR OTHER DOCUMENTATION.
- (b) ASSUMES NO RESPONSIBILITY OR LIABILITY FOR LOSS OR DAMAGE, WHETHER DIRECT, INDIRECT, CONSEQUENTIAL OR INCIDENTAL, WHICH MIGHT ARISE OUT OF THE USE OF SUCH INFORMATION. THE USE OF ANY SUCH INFORMATION WILL BE ENTIRELY AT THE USER'S RISK.

Date and Revision: June 25, 2008

## **Contact Information**

OutBack Power Systems  
19009 62nd Ave. NE, Arlington, WA 98223  
Phone (360) 435-6030  
Fax (360) 435-6019  
[www.outbackpower.com](http://www.outbackpower.com)

## Warranty Introduction

Dear OutBack Customer,

Thank you for your purchase of OutBack products. We make every effort to assure our power conversion products will give you long and reliable service for your renewable energy system.

As with any manufactured device, repairs might be needed due to damage, inappropriate use, or unintentional defect. Please note the following guidelines regarding warranty service of OutBack products:

- Any and all warranty repairs must conform to the terms of the warranty.
- All OutBack equipment must be installed according to their accompanying instructions and manuals with specified over-current protection in order to maintain their warranties.
- The customer must return the component(s) to OutBack, securely packaged, properly addressed, and shipping paid. We recommend insuring your package when shipping. Packages that are not securely packaged can sustain additional damage not covered by the warranty or can void warranty repairs.
- There is no allowance or reimbursement for an installer's or user's labor or travel time required to disconnect, service, or reinstall the damaged component(s).
- OutBack will ship the repaired or replacement component(s) prepaid to addresses in the continental United States, where applicable. Shipments outside the U.S. will be sent freight collect.
- In the event of a product malfunction, OutBack cannot bear any responsibility for consequential losses, expenses, or damage to other components.

Please read the full warranty at the end of this manual for more information.



**EU Declaration of Conformity**  
In accordance with EN 45014:1998

We ..... OutBack Power Systems  
Of ..... 19009 62nd Ave NE  
Arlington, WA 98223 USA

Declare that:

Model name/number ..... MATE, MATE2, MATE\_B, HUB4, HUB10

Has been designed and manufactured to the following specifications:

73/23/EEC ..... The Low Voltage Directive and its' amending directives

As the manufacturer, we declare that the equipment named above has been designed to comply with the relevant sections of the above referenced specifications. The unit complies with all essential requirements of the Directives.



Done at Arlington, WA USA  
On 1/22/08

## OUTBACK HUB Communications Manager

### INSTALLATION GUIDELINES AND SAFETY INSTRUCTIONS

#### SAVE THESE INSTRUCTIONS

Read all instructions, cautionary markings, and all appropriate sections of this installation and user manual as well as other component manuals before using the system.

Be cautious around electricity, electrical components, and batteries. Shocks, burns, injury, and even death can occur if an installer comes in contact with electricity.

This product is intended to be installed as part of a permanently grounded electrical system .

- The OutBack HUB is designed for indoor installation or installation inside a weatherproof enclosure.
- All wiring voltage is less than 30 volts DC (CAT5e communications cable) and considered a "limited energy circuit" which normally does not require conduit (consult your local code for specific installation requirements).
- Install all components and wiring according to national and local electrical and building codes. This may include submitting a plan to the local building department and passing an inspection.
- For full system protection, one FLEXware Surge Protector per FX Series Inverter/Charger should be installed.

OutBack Power Systems cannot be responsible for system failure, damages, or injury resulting from improper installation of their products.

**NOTE:** In the United States, it is a UL 1741 requirement for a grid-tie system to have surge protection. Installing an OutBack FW-SP is also recommended if your AC source is irregular or unreliable with power surges (due to a lower quality generator or inconsistent utility power, for instance).

## INTRODUCTION

OutBack Power Systems' HUB System Communications Manager allows multiple OutBack devices to connect and integrate at one point via CAT5e cable WITH RJ45 modular jacks.

There are two HUB Communication Manager products:

- HUB 4, which has four component ports plus a MATE port
- HUB 10, which has ten component ports plus a MATE port

When the MATE is attached to the HUB 4, it can display and manage any combination of four FX Series Inverters/Chargers and OutBack Charge Controllers. The OutBack HUB 10 allows the MATE to control up to 10 OutBack products of any combination.

**NOTE:** The OutBack HUB communicates stacking phase, load share, and incremental start-up and shut down information directly among the FX Series Inverter/Chargers. The HUB is powered by any FX or OutBack Charge Controller connected to it.

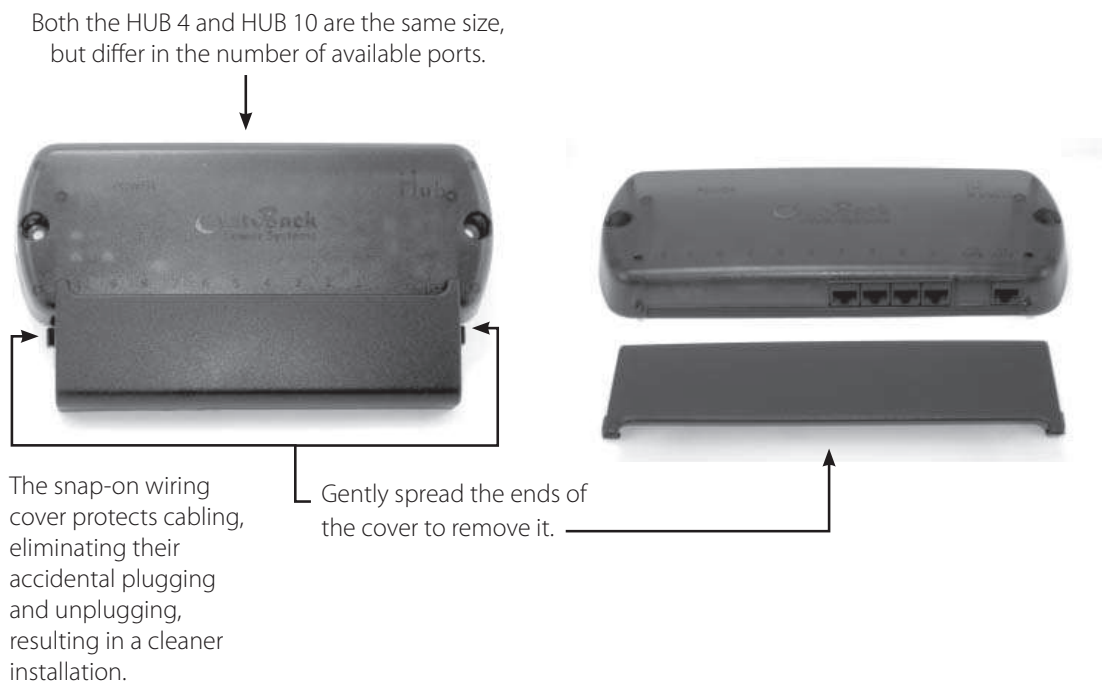

## HUB 10 and HUB 4 Parts

Each HUB comes with sufficient fasteners, cables and bushings for most common installations. Please see the enclosed hardware kit for specific parts.

### Accessories

OBCATV-3 Three-foot CAT5e cable with green jacket

OBCATV-6 Six-foot CAT5e cable with green jacket

OBCATV-10 Ten-foot CAT5e cable with green jacket

OBCATV-50 Fifty-foot CAT5e cable with green jacket

### Mounting

The OutBack HUB can be wall-mounted in any orientation. Both the FLEXware 500 and 1000 systems as well as previous OutBack enclosures have mounting holes for convenient HUB installation.

To mount a HUB to either a FLEXware 500 or 1000:

- Remove the knockout(s) from the side of the 500 or 1000
- Insert the snap-in bushing(s) supplied with the HUB.
- Secure the HUB using the supplied #10 sheet metal screws.
- Pull the CAT5e cable(s) through the knockout(s) and attach to the HUB Port(s).

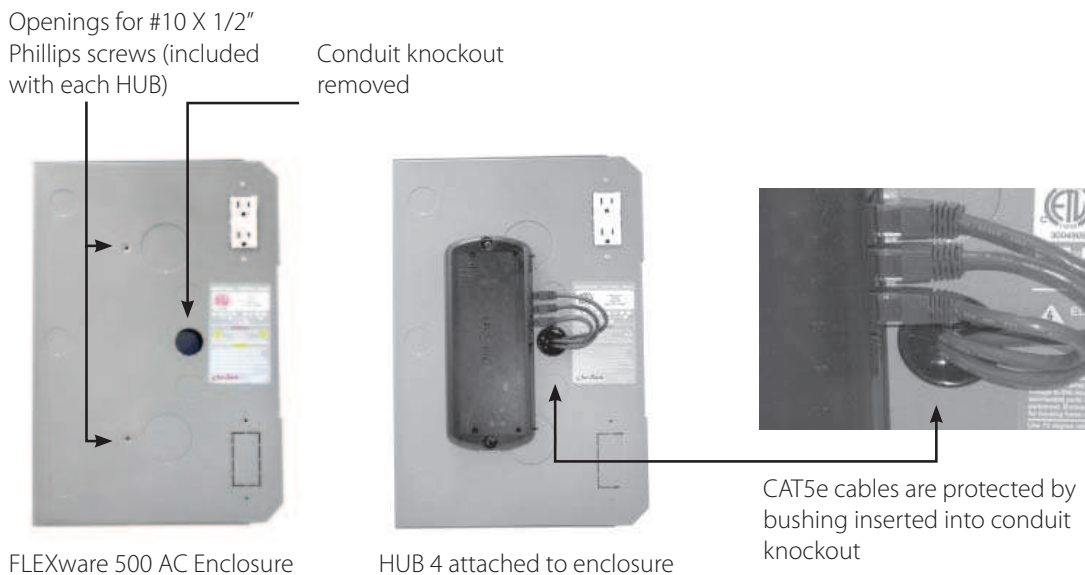

To mount to a wall or other secure non-enclosure surface:

Either HUB model can be attached using two 1 5/8" drywall screws or their equivalent.

## Connecting to the HUB

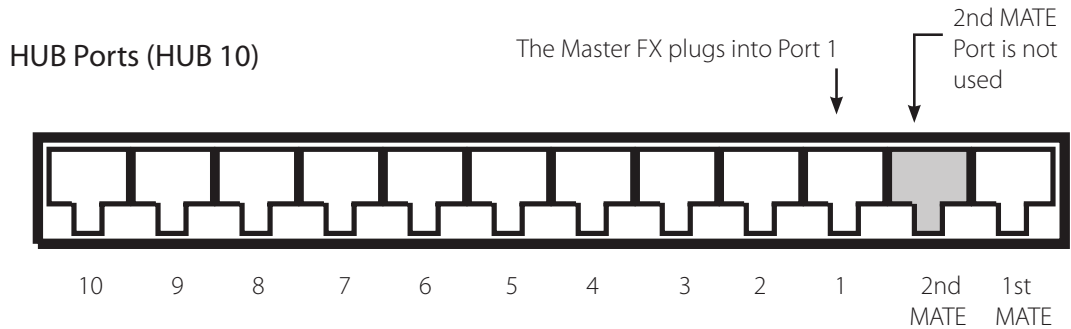

- With the HUB mounted, plug in the FX Inverter/Chargers starting with Port 1.
- Port 1's FX is the Master FX in a multiple FX system.
- When all the FXs are connected to the HUB, connect the Charge Controllers in any order.
- After all devices are connected to the HUB, the MATE is always plugged in last using the 1st MATE port.
- The 2nd MATE is inactive and should not be used.
- Connections can be made with FXs or OutBack Charge Controllers already powered up or simply power up all devices when the connections to the HUB are complete.
- After the devices are powered, the MATE will power up when it is connected; it will display a greeting and software revision information (see page 11)
- FX AC input breakers and AC output breakers should be open until stacking programming is complete.
- To operate, the HUB requires at least one FX or Charge/Controller to be plugged in.
- The MATE must be repolled to recognize any devices connected after it's activated (see page 12)

## HUB Operation

When the first powered OutBack product plugs into the HUB:

- The HUB will go through a power up sequence that flashes all of its LEDs.
- The POWER LED will remain on any time that one or more powered OutBack products are connected.
- After the MATE is connected it will start communicating with all connected devices.
- Each Port has an LED associated with it that is visible through the cover.
- Any device that is plugged in should have a flickering LED when the MATE is communicating with it.

**Note:** In order to operate correctly, the HUB requires that the MATE be code version 2.0 or higher. (See "Checking the MATE Version" in the Troubleshooting section and/or see the MATE User Manual for more information.)



## Common Wiring Configurations

### Single FX Series Inverter/Charger and OutBack Controller

- Plug the FX into Port 1 of the HUB.
- The Charge Controller and any future OutBack devices can be plugged into any remaining non-MATE ports.

### Multiple OutBack Charge Controllers Only

- Plug one Charge Controller into Port 1 and the others into any remaining ports.
- A FLEXnet DC can be plugged into a remaining port as well.

### Series/Parallel Phase-Stacked FX Series Inverter/Chargers

- The FX designated as the Master must be plugged into Port 1.
- Plug additional FXs in remaining ports in numerical order followed by any OutBack Charge Controllers.
- Some PC monitoring software requires that 120/240 VAC series-stacked or series parallel stacked FX Systems be wired with all LEG 1 (L1) phased FXs as odd numbered Ports and all LEG 2 (L2) phased FXs as even numbered Ports. This arrangement also makes programming the FX Slave power save level settings more intuitive.

### Three- Phase FX Series Inverter/Charger Stacking

- Connect the Master FX (Phase A) to Port 1.
- Connect the phase B Slave to Port 2.
- Connect the phase C Slave to Port 3.
- The HUB jumper must be in the three phase position as described in the three- phase stacking section (please see next page).
- Other OutBack devices can be plugged into any unused ports. Currently, only three inverters can be configured in a three-phase arrangement, but additional non-stacked inverters—all of which must be Masters—can be plugged into any of the unused ports of the HUB.
- These non-stacked inverters can only power loads that are independent of the three-phase loads; additional AC load panels will be required.

## Three-Phase Stacking Only

The OutBack HUB is shipped from the factory setup for series (120/240 VAC split phase) and/or parallel (120 VAC or 230 VAC single phase) stacking. If three-phase stacking is desired, the cover must be removed and a jumper position changed. For three-phase stacking using a HUB 4:

1. Remove the black snap on wiring cover and all cables plugged into the HUB. Label the cables to avoid confusion when reconnecting.

2. Remove the four Phillips screws from the bottom of the HUB.



Bottom cover removed



3. Remove bottom cover and remove the four Phillips screws holding the green PCB to the upper cover.

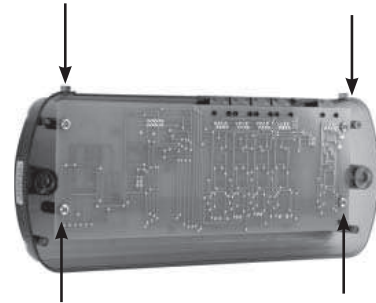

PCB removed

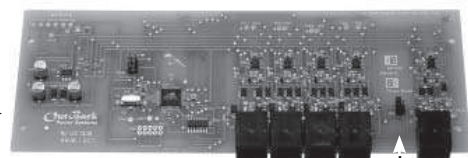

Jumper



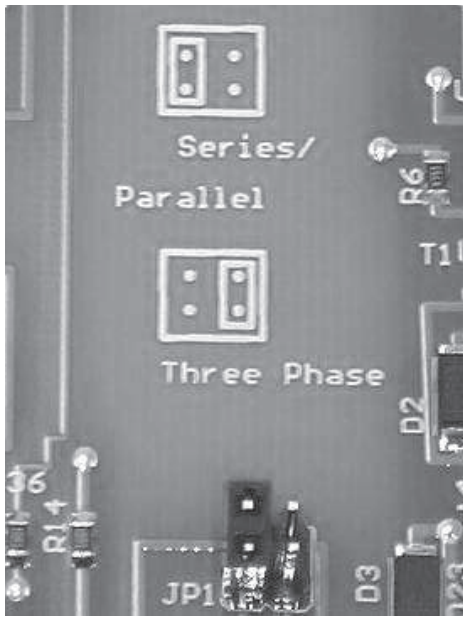

Series/Parallel location

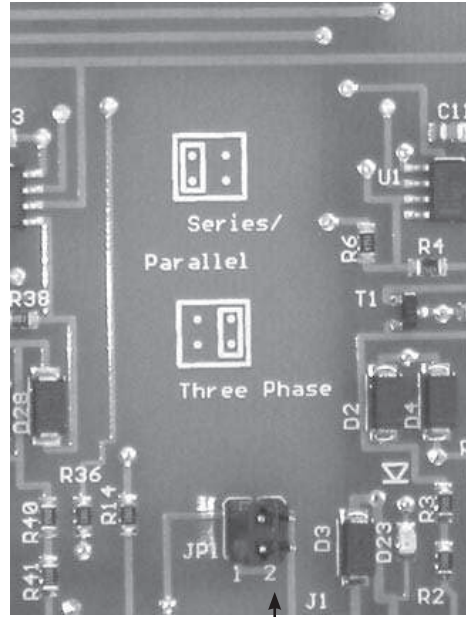

Three-Phase location

4. Move the plug-in jumper from the series/parallel location to the three-phase location.
5. Replace the PCB and bottom cover, the snap on wiring cover, and all CAT5e cables.

For three-phase stacking using a HUB 10, follow the same disassembly and assembly instructions as for a HUB 4, but note that the jumper is in a different location as shown below.

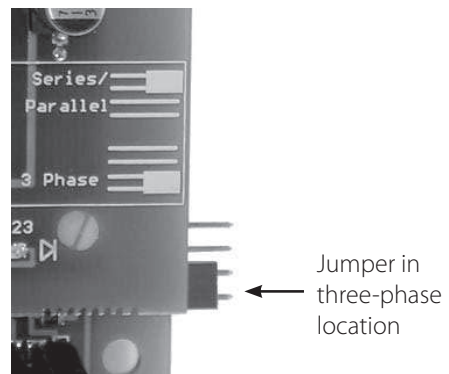
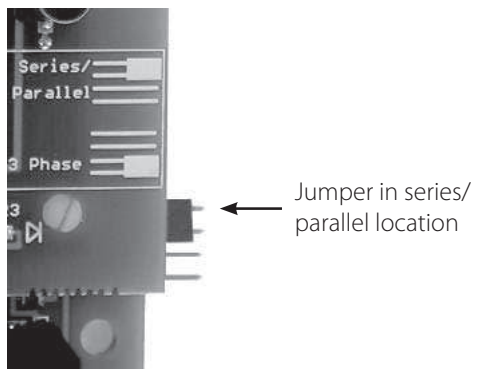
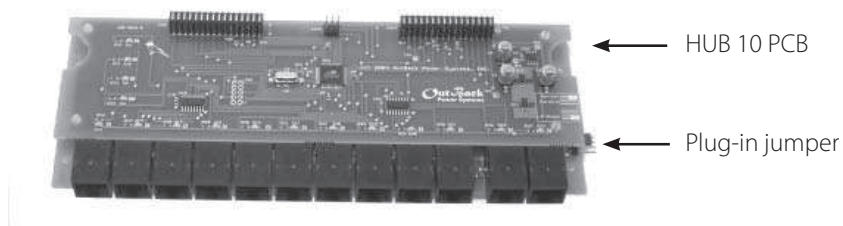

## Sample Network Configuration

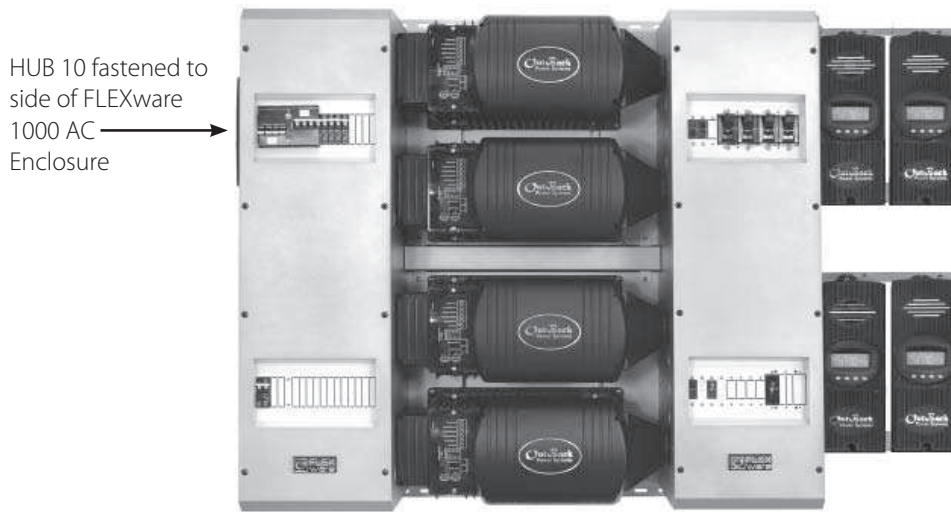

FLEXware 1000 System

OutBack HUB 10 connected to four FX Series Inverter/Chargers and four Charge Controllers

## MATE Power Up

As soon as the MATE cable is plugged into a powered OutBack product, the MATE itself will power-up and display several information screens.

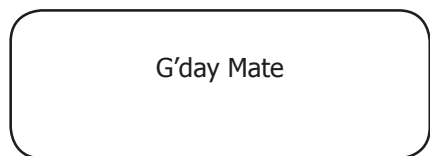

First Screen

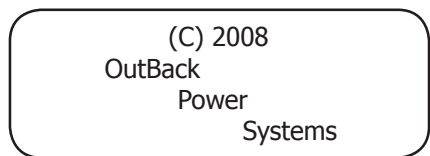

Second Screen

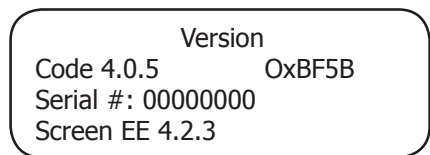

Third Screen

- "Code" dictates the MATE's operation and features
- "Serial #" matches the bar code sticker inside the MATE, behind the back cover
- "Screen EE" refers to the MATE's menu system



Searching  
for Devices  
HUB FOUND

MATE has found the HUB



Port Assignment  
1> FX 2> MX 3> 4>  
5> 6> 7> 8>  
9> 10> 2M>

Port Assignment screen follows the "HUB Found" screen, each Port showing the product connected to it



Silent P01  
inv 0.0 kw zer 0.0 kw  
chg 0.0kw buy 0.0 kw  
DOWN STATUS PORT

While navigating the various screens and menus in the MATE, the information displayed often only applies to a single device on a single Port. In these cases, the Port number is displayed in the upper right hand corner of the MATE screen. To navigate through the Ports, use the **<PORT>** soft key.



## Adding a Device to an Operating HUB

Any time an OutBack device is removed or added to a HUB or its Port is changed, the MATE must re-poll the system to find the locations of all the new or moved devices. This is accomplished by unplugging and re-plugging the MATE from the HUB, or by the following procedure.

**NOTE:** Turn off all AC output breakers before connecting and programming new devices added to the HUB.

From the MAIN screen, press the **<SETUP>** soft key

MAIN-----  
12:00:00P  
SUM STATUS SETUP ADV



Press the **<MATE>** soft key

SETUP -----  
choose device:  
FX MATE



Press the **<PG2>** soft key

SETUP/MATE/PAGE1-----  
mate code rev: 4.0.5  
choose category:  
CLOCK CNT GLOW PG2



Press the **<COMM>** soft key

SETUP/MATE/PAGE2-----  
choose category:  
PG1 SUMRY COMM PG3



Press the **<REPOLL>** soft key

SETUP/MATE/ COMM-----  
choose category:  
BACK REPOLL PC DEBUG



After repolling, the MATE will display a *Searching for Devices* screen followed by the *Port Assignment* screen before returning to the *choose category* screen. MATEs with software revision 4.0.0 or higher repoll automatically every 30 seconds.

## Troubleshooting

### Problem

HUB power LED does not light

### Action

The HUB is powered from OutBack Power FXs or Charge Controllers. Be sure all DC breakers for HUB-connected devices are on. Check or replace connecting CAT5e cables if needed.

MATE does not find the hub

Check the MATE code version is 2.0 or higher. Check and if necessary replace CAT5e cables connecting any device to the HUB.

MATE does not see all connected devices

Verify that all connected devices have DC power applied and are functioning properly. Check or replace CAT5e cables running from the HUB to the OutBack products. If any OutBack products were added or moved on the HUB while the MATE was powered, follow the instructions in *Adding a Device to an Operating HUB* section

MATE displays a 'COMM ERROR'

If the MATE receives too many interrupted or corrupt communications with HUB-attached devices, it will display a COMM ERROR screen. Choosing VIEW DEBUG brings up a screen listing all ports and accumulated errors. Any Port experiencing errors can be found by the error count after the Port number. In the example below, Port 4 has a large number of errors detected (04:025 means Port 4: showing 25 errors). Pressing any key will return to the SETUP/MATE/COMM screen, which allows error counts to be reset using the 'RSET' button. The DEBUG screen can be re-displayed by using the VIEW button, or user can get back to the SETUP menu by using the BACK button. Use the information on the DEBUG screen to locate the problem device. Make sure the device's DC breaker is on, and that it is operating correctly. Check or replace CAT5e cables running from the HUB to that device.

|        |          |        |
|--------|----------|--------|
| 00:000 | 01:000   | 02:000 |
| 03:000 | ▶ 04:025 | 05:001 |
| 06:001 | 07:001   | 08:001 |
| 09:001 | 10:001   | 2M:001 |

25 errors on Port 4

## TWO YEAR LIMITED WARRANTY INFORMATION

### Hub Communications Manager Products

OutBack Power Systems, Inc. ("OutBack") provides a two year (2) limited warranty ("Warranty") against defects in materials and workmanship for its Hub Communications Manager Products ("Product(s)") if installed in fixed location applications.

The term of this Warranty begins on the Product(s) date of manufacture or the initial purchase date as indicated on the warranty registration card submitted to OutBack, whichever is greater. This Warranty applies to the original OutBack Product(s) purchaser, and is transferable only if the Product(s) remains installed in the original use location. The warranty does not apply to any Product(s) or Product(s) part that has been modified or damaged by the following:

- Installation or Removal;
- Alteration or Disassembly;
- Normal Wear and Tear;
- Accident or Abuse;
- Corrosion;
- Lightning;
- Repair or service provided by an unauthorized repair facility;
- Contrary to manufacturer product instructions;
- Fire, Floods or Acts of God;
- Shipping or Transportation;
- Incidental or consequential damage caused by other components of the power system;
- Any product whose serial number has been altered, defaced or removed; or
- Any other event not foreseeable by OutBack.

OutBack's liability for any defective Product(s), or any Product(s) part, shall be limited to the repair or replacement of the Product(s), at OutBack's discretion. OutBack does not warrant or guarantee workmanship performed by any person or firm installing its Product(s). This Warranty does not cover the costs of installation, removal, shipping (except as described below), or reinstallation of Product(s).

To request warranty service, you must contact OutBack Technical Services at (360) 435-6030 or support@outbackpower.com within the effective warranty period. OutBack Technical Support will attempt to troubleshoot the product and validate that the failure is product related. If warranty service is required, OutBack will issue a Return Material Authorization (RMA) number. A request for an RMA number requires all of the following information:

1. Proof-of-purchase in the form of a copy of the original Product(s) purchase invoice or receipt confirming the Product(s) model number and serial number;
2. Description of the problem; and
3. Shipping address for the repaired or replacement equipment.

After receiving the RMA number, pack the Product(s) authorized for return, along with a copy of the original purchase invoice, in the original Product(s) shipping container(s) or packaging providing equivalent protection and mark the outside clearly with the RMA number. The sender must prepay all shipping charges to the agreed upon OutBack Power Systems location, and insure the shipment, or accept the risk of loss or damage during shipment. OutBack is not responsible for shipping damage caused by improperly packaged Products, the repairs this damage might require, or the costs of these repairs. If, upon receipt of the Product(s), OutBack determines the Product(s) is defective and that the defect is covered under the terms of this Warranty, OutBack will then and only then ship a repaired or replacement Product(s) to the purchaser freight prepaid, non-expedited, using a carrier of OutBack's choice, where applicable.

The warranty period of any repaired or replacement Product is twelve (12) months from the date of shipment from OutBack, or the remainder of the initial warranty term, whichever is greater.

THIS LIMITED WARRANTY IS THE EXCLUSIVE WARRANTY APPLICABLE TO OUTBACK PRODUCTS. OUTBACK EXPRESSLY DISCLAIMS ANY OTHER EXPRESS OR IMPLIED WARRANTIES OF ITS PRODUCTS, INCLUDING BUT NOT LIMITED TO ANY IMPLIED WARRANTIES OF MERCHANTABILITY OR FITNESS FOR A PARTICULAR PURPOSE. OUTBACK ALSO EXPRESSLY LIMITS ITS LIABILITY IN THE EVENT OF A PRODUCT DEFECT TO REPAIR OR REPLACEMENT IN ACCORDANCE WITH THE TERMS OF THIS LIMITED WARRANTY AND EXCLUDES ALL LIABILITY FOR INCIDENTAL OR CONSEQUENTIAL DAMAGES, INCLUDING WITHOUT LIMITATION ANY LIABILITY FOR PRODUCTS NOT BEING AVAILABLE FOR USE OR LOST REVENUES OR PROFITS, EVEN IF IT IS MADE AWARE OF SUCH POTENTIAL DAMAGES. SOME STATES (OR JURISDICTIONS) MAY NOT ALLOW THE EXCLUSION OR LIMITATION OF WARRANTIES OR DAMAGES, SO THE ABOVE EXCLUSIONS OR LIMITATIONS MAY NOT APPLY TO YOU.





## HUB Communications Manager Limited Warranty Registration

**Complete this form and return it to:**

Outback Power Systems Inc.  
19009 62nd Ave. NE  
Arlington, WA 98223

NOTE: Please submit a copy (not the original) of the Product purchase invoice, which confirms the date and location of purchase, the price paid, and the Product Model and Serial Number.

### HUB Communications Manager Limited Warranty Registration

#### System Owner

Name: \_\_\_\_\_ Country: \_\_\_\_\_  
Address: \_\_\_\_\_ Telephone Number: \_\_\_\_\_  
City, State, Zip Code: \_\_\_\_\_ E-mail: \_\_\_\_\_

#### Product

Product(s) Model Number(s): \_\_\_\_\_ Sold by: \_\_\_\_\_  
Product(s) Serial Number(s): \_\_\_\_\_ Purchase Date: \_\_\_\_\_

Please circle factors affecting your purchase decision:

- Price
- Product Reputation
- Product Features
- Reputation of OutBack Power Systems
- Value

#### System

System Install/Commission Date: \_\_\_\_\_ Total Nominal System AC Output in KW: \_\_\_\_\_  
Nominal System AC Voltage: \_\_\_\_\_ System Battery Bank Size (Amp Hours): \_\_\_\_\_  
Type of Batteries: \_\_\_\_\_

Are you using a generator with this system? (Circle One): Yes No

If yes, please list the make and model: \_\_\_\_\_

If yes, is the generator's output is (Circle One): AC DC

#### Installer:

Contractor Number (If Applicable) \_\_\_\_\_ Installer Address: \_\_\_\_\_  
Installer City, State, Zip: \_\_\_\_\_ Installer E-mail: \_\_\_\_\_

#### \*Extended Warranty

OutBack Power Systems offers an optional three (3) year extension to the standard two (2) year Limited Warranty for the Hub Communications Manager Products. To request a 3-year Limited Warranty extension for a total effective warranty coverage period of five (5) years; include a check or money order in the amount of \$50USD for a Hub 10 or \$35USD for a Hub 4 payable to OutBack Power Systems, Inc. along with your Warranty Registration.

Revision.2008-04-01





Corporate Office  
19009 62nd Avenue NE  
Arlington, WA USA  
(+1) 360-435-6030

[www.outbackpower.com](http://www.outbackpower.com)

European Sales Office  
C/ Castelló, 17  
08830 - Sant Boi de Llobregat  
BARCELONA, España  
Phone: +34.93.654.9568

900-0004-01-00 REV B