

PS2-600 CS-F3-7

Solar Surface Pump System

System Overview

Head	max. 40 m
Flow rate	max. 5,2 m³/h

Technical Data

Controller PS2-600

- Controlling and monitoring
- Control inputs for dry running protection, remote control etc.
- Protected against reverse polarity, overload and overtemperature
- Integrated MPPT (Maximum Power Point Tracking)
- Battery operation: Integrated low voltage disconnect

Power	max. 0,70 kW
Input voltage	max. 150 V
Optimum Vmp**	> 68 V
Motor current	max. 13 A
Efficiency	max. 98 %
Ambient temp.	-40...50 °C
Enclosure class	IP68

Motor ECDRIVE 600 CS-F

- Maintenance-free brushless DC motor
- Premium materials, stainless steel: AL/AISI 304

Rated power	0,7 kW
Efficiency	max. 92 %
Motor speed	900...3.300 rpm
Insulation class	F
Enclosure class	IPX4

Pump End PE CS-F3-7

- Premium materials
- Optional: dry running protection
- Centrifugal pump



Pump Unit PU600 CS-F3-7 (Motor, Pump End)

Water temperature	max. 70 °C
Suction head	acc. to COMPASS sizing

Standards



2006/42/EC, 2004/108/EC, 2006/95/EC

IEC/EN 61702:1995

The logos shown reflect the approvals that have been granted for this product family. Products are ordered and supplied with the approvals specific to the market requirements.

**Vmp: MPP-voltage under Standard Test Conditions (STC): 1000 W/m² solar irradiance, 25 °C cell temperature



PS2-600 CS-F3-7

Solar Surface Pump System

Pump Chart

Vmp* > 68 V

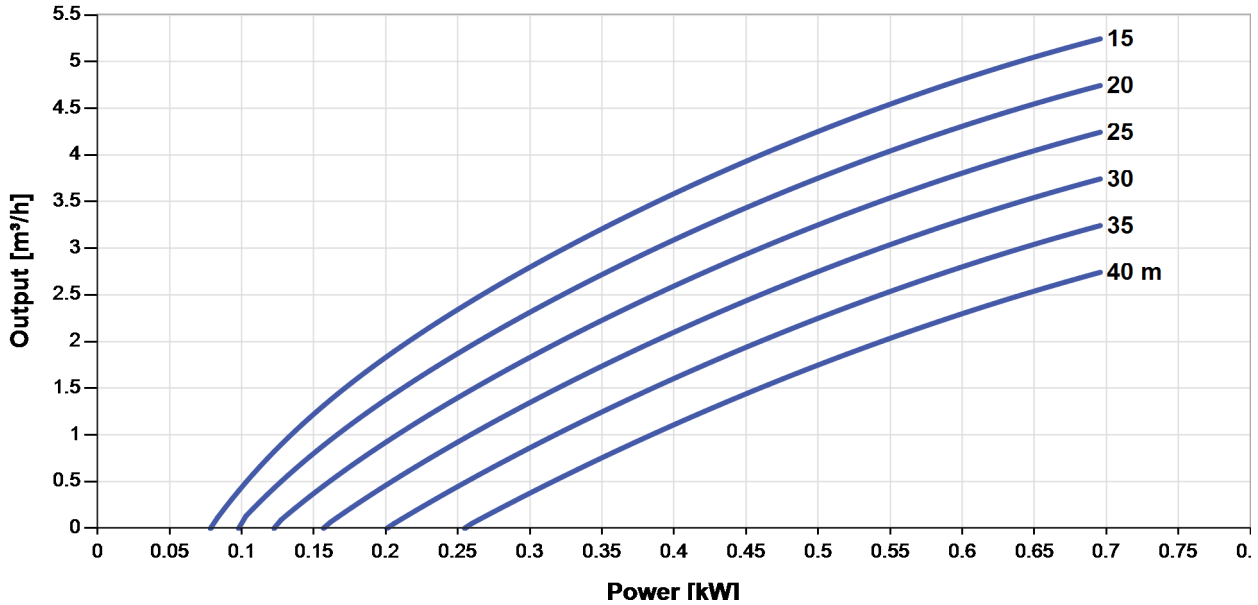

NPSH

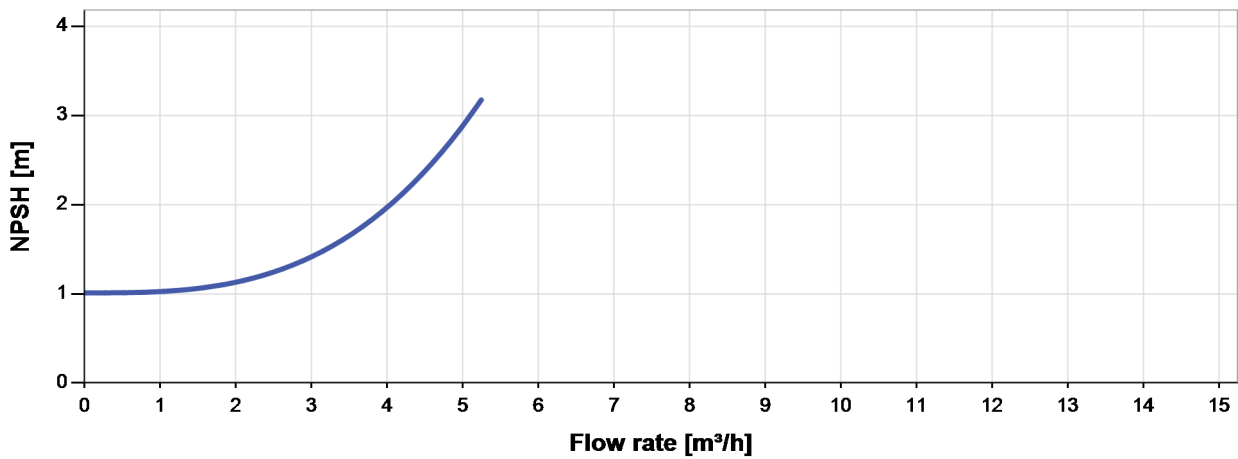

The NPSH (Net Positive Suction Head) is NOT the operating suction head. To calculate the operating suction head please refer to the installation manual.

*Vmp: MPP-voltage under Standard Test Conditions (STC): 1000 W/m² solar irradiance, 25 °C cell temperature



PS2-600 CS-F3-7

Solar Surface Pump System

Dimensions and Weights

Controller

H1 = 352 mm
 H2 = 333 mm
 W1 = 207 mm
 W2 = 170 mm
 W3 = 164 mm
 D1 = 124 mm

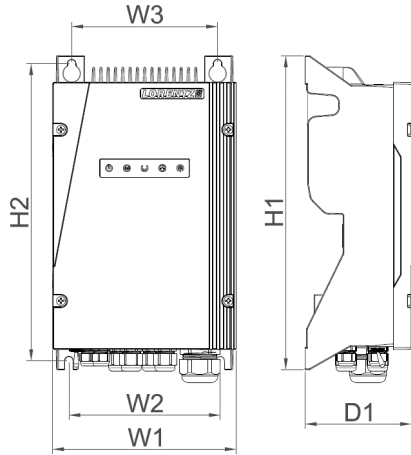

Pump Unit

A = 120 mm
 B = 110 mm
 C = 200 mm
 D = 250 mm
 E = 150 mm
 F = 100 mm
 G = 75 mm
 H = 348 mm
 I = G1/2"
 J = 210 mm
 K = 180 mm
 L = 32 mm
 M = 85 mm
 N = 14 mm
 O = 32 mm
 P = 13 mm

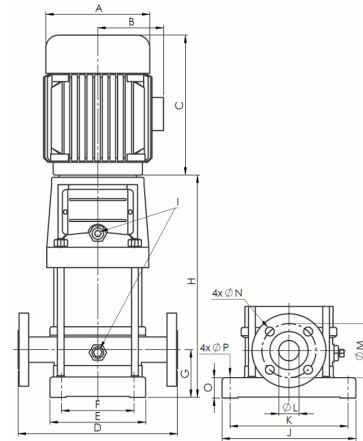

	Net weight
Controller	5,6 kg
Pump Unit	15 kg
Motor	7,5 kg
Pump End	7,0 kg

