

Rolls

S2-535GEL
2V 535 AH @C20

TUBULAR POSITIVE - OPzV - VALVE REGULATED GEL BATTERY



CONSTANT CURRENT DISCHARGE

CUT OFF VOLTAGE V/CELL	30MIN	1HR	2HR	3HR	4HR	6HR	8HR	10HR	20HR
1.75V	390.0	278.5	173.5	126.1	98.50	76.50	59.17	51.00	26.78



Rolls

BATTERY ENGINEERING
BY SURRETTE BATTERY COMPANY

SPECIFICATIONS

Nominal Voltage		2 Volt
Rated Capacity (20 hour rate)		535 AH
Dimensions	Total Height (including terminals)	506mm / 19.92"
	Length	166mm / 6.54"
	Width	206mm / 8.11"
	Weight	87.08 lbs / 39.5 Kg



CHARACTERISTICS

Capacity 77°F (25°C)	100 Hour Rate	625 AH
	20 Hour Rate	535 AH
	10 Hour Rate	490 AH
Internal Resistance	Full charged Battery 77°F (25°C)	0.35mΩ
Capacity Affected by Temperature (20hr rate)	104°F (40°C)	105%
	77°F (25°C)	100%
	32°F (0°C)	89%
	5°F (-15°C)	79%
Self-Discharge	Less than 2% per month at 77°F (25°C)	
Max Discharge 77°F (25°C)	2000A (5s)	
Terminal	Standard	Thread insert & Bolt (F10-M8)
Float Charging Voltage Range		2.25 to 2.3 VDC/unit Average at 25°C
Max Charge Current		100 Amps

CYCLE LIFE

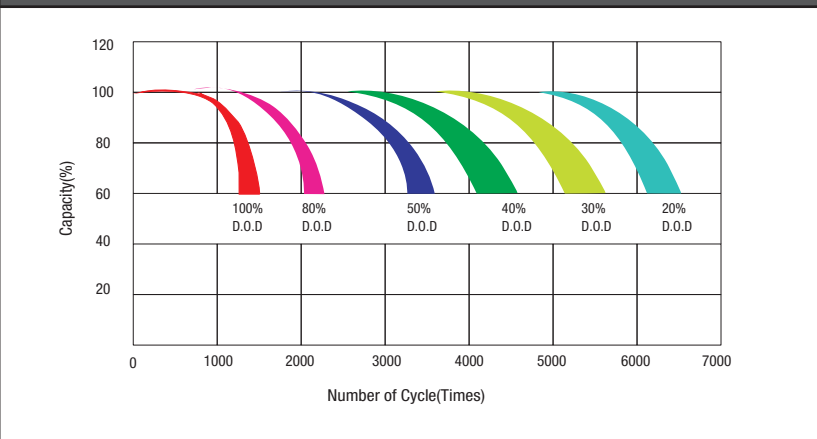

SIZE & DETAILED ILLUSTRATION

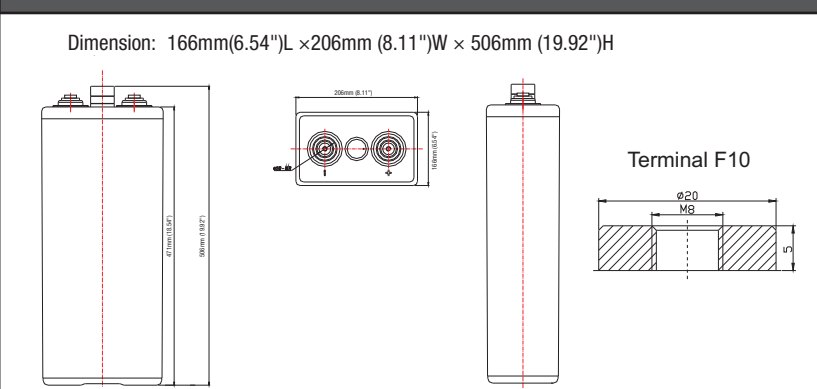

TEMP EFFECTS ON LIFE AT FLOAT CHARGE

